

AVK PRESSURE MANAGEMENT SOLUTION



SMART PRESSURE MANAGEMENT

Expect... **AVR**

CONTENT:



- DEVELOPING AN EFFECTIVE LEAKAGE MANAGEMENT STRATEGY 4 - 5

- PRESSURE MANAGEMENT – OPTIMIZING WATER DISTRIBUTION 6 - 7

- IMPLEMENTATION OF PRESSURE MANAGEMENT 8 - 9

- WHY IS AVK THE BETTER CHOICE? 10-11

- USING CONTROL VALVES TO OPTIMIZE PRESSURE..... 12-15

- INTELLIGENT CONTROL VALVES DEMAND DRIVEN PRESSURE MANAGEMENT 16-17

- INTELLIGENT CONTROL VALVES ARE A VITAL TOOL FOR SMART NETWORKS!..... 18-19

- CASE STORY: RANDERS 20-21

- CASE STORY: TBILISI, GEORGIA – GEORGIA WATER AND POWER 22-23

DEVELOPING AN EFFECTIVE LEAKAGE MANAGEMENT STRATEGY

Water is a scarce resource that we need to protect and use with great respect. We need to secure water for the next generation and a growing population. A major challenge facing many municipalities is how to deal with high levels of water loss, or Non-Revenue Water (NRW). High volumes of clean water are lost through leaks and overflow (real losses), and are not accounted for due to metering inaccuracies at consumers and illegal connections (apparent losses). A large portion of NRW is made up of leakage in the distribution system. The composition of NRW is shown in the IWA Water Balance.

SYSTEM INPUT VOLUME	AUTHORISED CONSUMPTION	BILLED AUTHORISED CONSUMPTION	BILLED METERED CONSUMPTION	REVENUE WATER
			BILLED UNMETERED CONSUMPTION	
		UNBILLED AUTHORISED CONSUMPTION	UNBILLED METERED CONSUMPTION	NON REVENUE WATER
			UNBILLED UNMETERED CONSUMPTION	
	WATER LOSSES	APPARENT LOSSES (COMMERCIAL LOSSES)	UNAUTHORISED CONSUMPTION	
			CONSUMER METER INACCURACIES	
		REAL LOSSES (PHYSICAL LOSSES)	LEAKAGE ON TRANSMISSION AND DISTRIBUTION MAINS	
			LEAKAGE AND OVERFLOWS AT STORAGE TANKS	
			LEAKAGE ON SERVICE CONNECTIONS UP TO POINT OF CONSUMER METER	

Although there are many reasons for leakage such as corrosion, ground movements, or traffic load, in many cases, bursts have been triggered by high and fluctuating pressure, which could have been avoided by efficient pressure management.

High and fluctuating pressure not only causes substantial leakage and burst, but also brings adverse consequences such as reduced infrastructure lifetime and unnecessary high energy consumption for pumping of the water.



Developing an effective leakage management strategy to reduce NRW is essential. A successful leakage management strategy requires four components:

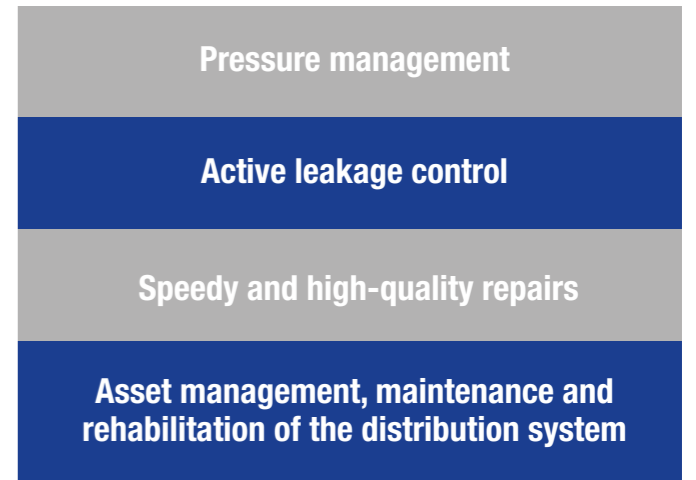

These factors influence how leakage is managed – and therefore the volume and economic value of leakage – in any utility’s distribution network.

Real Losses can be constrained and managed by an appropriate combination of all of the four management activities shown as arrows. The concept is the IWA “Squeeze the Box Approach”, also mentioned as the “Four Components Approach”.

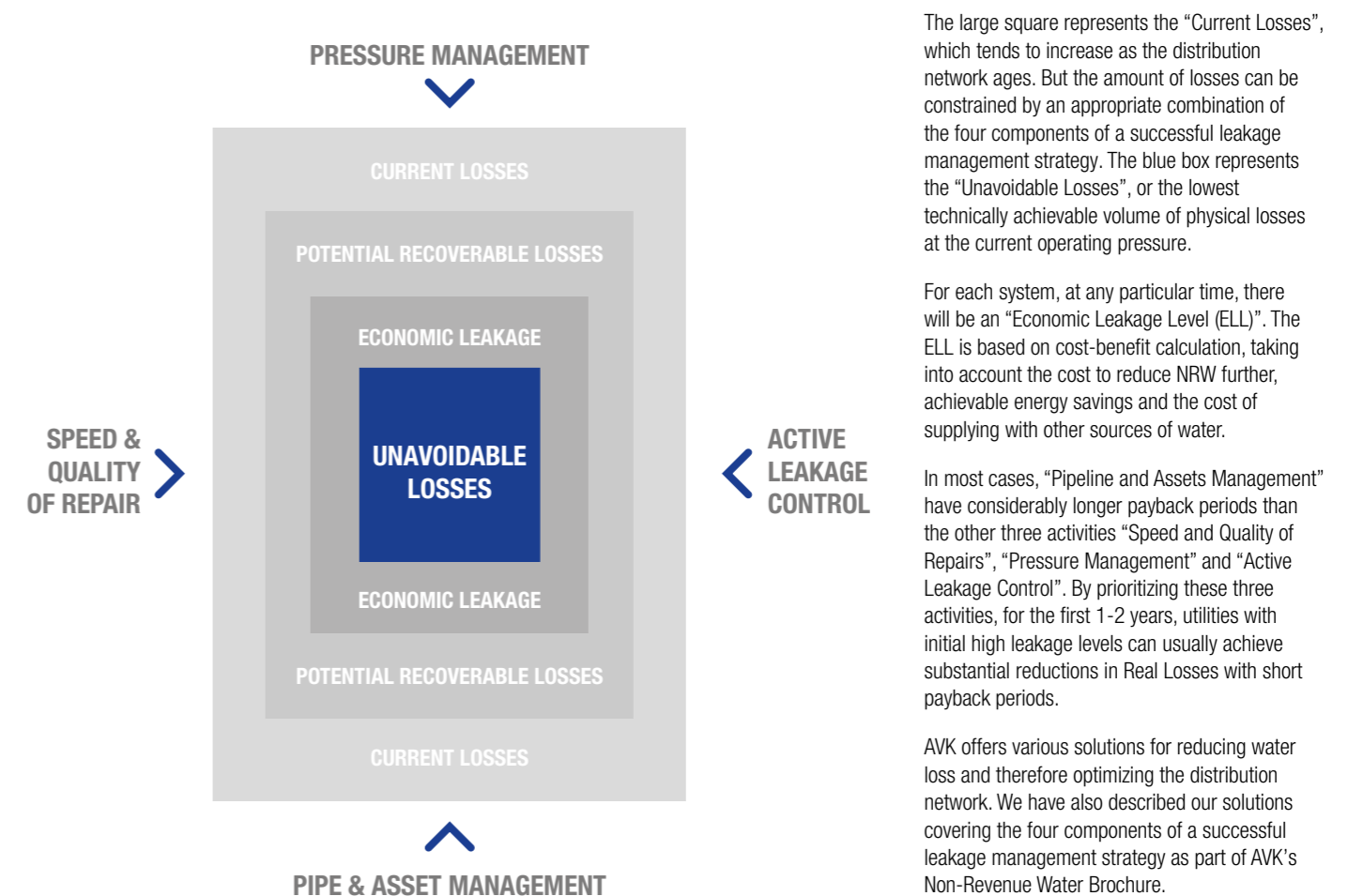

PRESSURE MANAGEMENT – OPTIMIZING WATER DISTRIBUTION



Pressure management is considered the most beneficial, important and cost effective leakage management activity. It is the fundamental foundation for optimal management of water distribution systems ensuring sufficient and efficient supply to legitimate users and consumers.

Good pressure management will allow water utilities to increase their efficiency in water distribution by improving their performance in water loss management. This can be of even greater benefit in water systems characterized by old infrastructure with reduced residual life. Pressure management can reduce the stress on infrastructure, extending its life time, while reducing and re-addressing the need for capital investments.

It is well-known that one of the major factors that influence the leakage rate is a high pressure in the distribution system. Most pipe bursts occur not only because of high pressure but rather due to ongoing pressure fluctuations that force the pipe to continually expand and contract, resulting in stress on infrastructure. Therefore, it is critical to reduce to a low constant pressure in the system. A low constant pressure has many advantages:

- Minimized water loss through leakages
- Minimized risk of pipe burst
- Reduced risk of contamination of water
- Reduced stress on infrastructure and extended asset life time
- Less disruption to consumers
- Energy saving for pumping
- Cost savings for water utilities

Pressure / Burst frequency Relationship

Pressure level and pressure variations in the network strongly influence pipe burst frequency. It is crucial to introduce pressure management, which can lead to a significant reduction in burst frequency. An international study on more than 100 cases has shown a reduction of bursts with average around 50% after the implementation of pressure management.

Pressure / Leakage Relationship

The common factor in every system is the fact that leakage is driven by pressure and if the pressure is increased, the leakage will also increase. Conversely, if the water pressure can be reduced, even for part of the day, the leakage will also decrease.

Energy saving

Pressure management can reduce energy consumption for pumping by allowing for a lower pressure in general and especially during off-peak hours. The pressure will be adjusted to the critical pressure at a strategical consumer in the DMA, which means that no energy will be used to pump water to a higher level than necessary.

Simple basis for predicting % reduction in bursts to % reduction in pressure

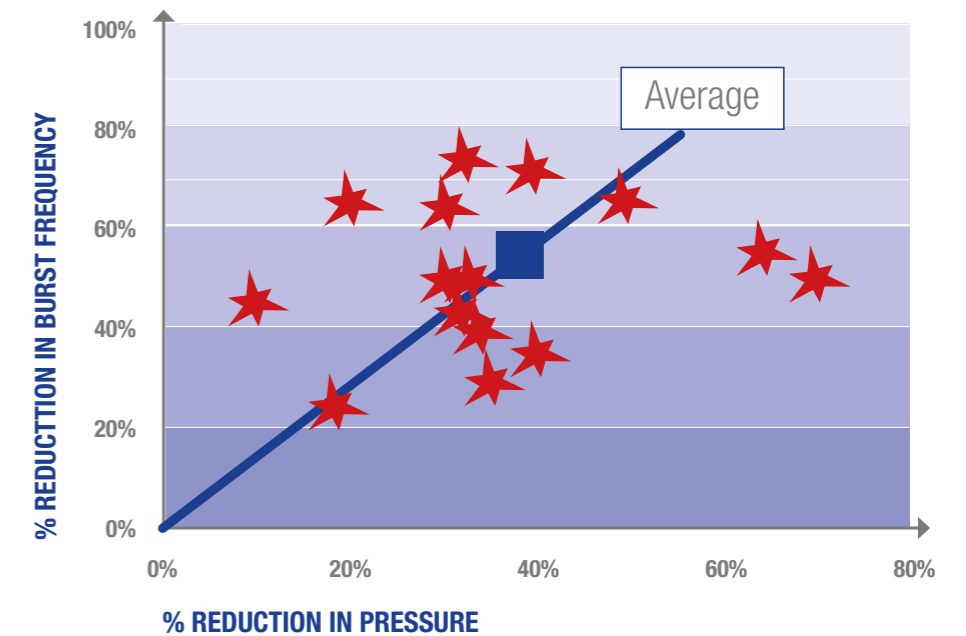

Based on study, a simple interpretation is to assume that the % reduction in new bursts = BFF x % reduction in maximum pressure, where BFF is a Burst Frequency Factor. The average value of BFF for Mains and Service connections is 1.4. That means that a reduction by 36% in pressure will result in 50% reduction in bursts, by using the BFF of 1.4.

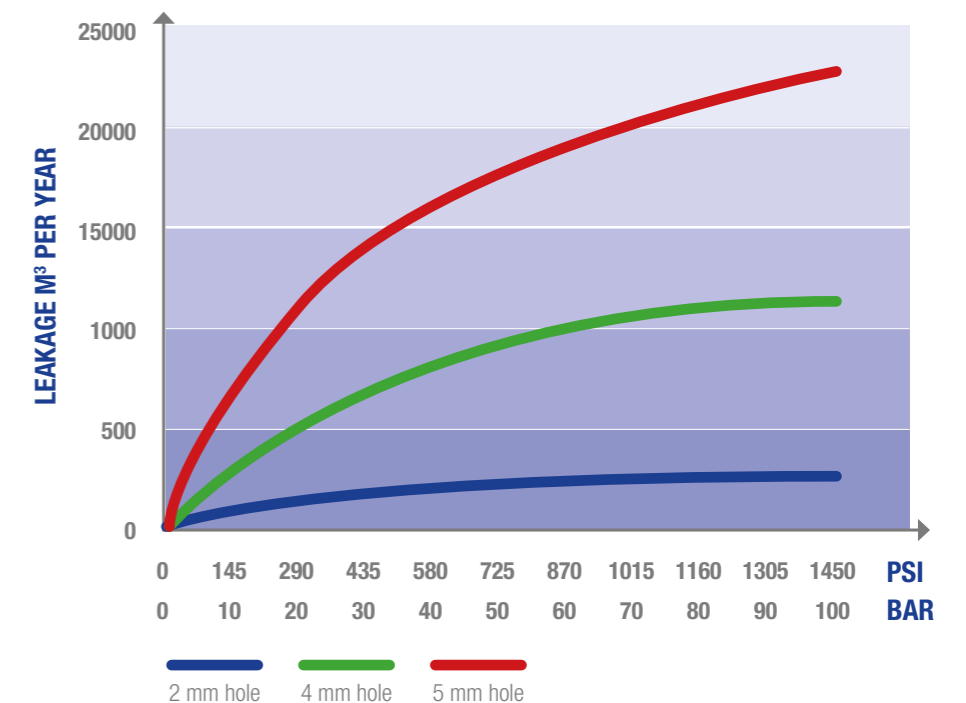

The relationship between pressure and leakage will conform to a square-root relationship ($N1 = 0.5$) in cases where the size of the leakage path (i.e. hole) remains constant during the change in pressure. This is the typical situation when the leak is a small hole in an iron or steel pipe (i.e. a fixed area leak) in which case doubling pressure will result in approximately a 41% increase in leakage. In the case of leaks from plastic pipes or from cracks in asbestos cement pipes, the surface area of the leakage path does not remain constant when the pressure changes and such leaks will often open up to create a larger hole through which the water can leak. Such leaks are referred to as variable area leaks and if the pressure is doubled, the leakage will increase more than from a fixed area leak. In some cases, the leakage may increase by as much as 8 times the original level.

IMPLEMENTATION OF PRESSURE MANAGEMENT

Pressure management shall be implemented within each of DMAs (District Metered Areas). DMA with pressure management is also called PMA (Pressure Management Area).

The aim is to reduce pressure within the DMA to a minimum without affecting the supply of the consumers. There is no point in keeping the same high water pressure in the network during night-time as has been defined for the daytime. Another aspect is that when the water consumption is low, the pressure in the network increases to the maximum adjustable pressure, and when water is consumed, the pressure drops or fluctuates according to the consumption. It means that the pipes are constantly exposed to a variable pressure and most of the time unnecessarily high pressure, which will eventually damage the pipes and cause bursts.

In pressure management, critical points must be established to determine the water pressure by means of a control valve. A critical point is a consumer within the DMA; it could be a building with the need for delivering water to the top floor, or a larger water consuming industry. The critical points regulate the pressure level in the DMA.



WHY IS AVK THE BETTER CHOICE?

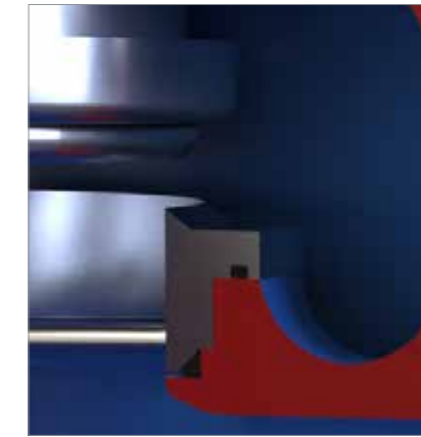

Outstanding design features of the main valve

- Large diaphragm design (1) secures fast reaction to changes in pressure. Its asymmetric axial position gives less stress near closed position.
- Lifted seat design (2) prevents damage inside the valve body caused by cavitation.
- Parabolic plug design (3) provides precise regulation and stability at low flow. Furthermore, it reduces noise and vibration.



Patented pilot system

- Modular pilot system enables easy fitting to other applications without replacing the valve
- Independent control of opening/closing speed
- Hand-adjustment of pilot – no tools needed
- Standard threads

As the components of the distribution system are placed underground, it is essential that the valves used are of the best quality, because they have to function reliable and be drop tight for many years without possibility for inspection. AVK valves provide this high level of reliability and long durability.



The safe choice with 10-year warranty

AVK control valves are designed according to EN 1074-5 and to provide network stability, accurate regulation, easy maintenance and long durability. AVK design and manufacture with 100% pressure test. In a long-term run, AVK control valves have the lowest Cost of Ownership in the market.

High quality materials and compact design

- All non-coated metal parts of stainless steel AISI 316 as standard
- Fusion bonded GSK approved epoxy coating (300 micron)
- AVK's own drinking water approved rubber compounds
- Compact design takes up less space



Pressure reducing valve



Pressure sustaining/relief valve

USING CONTROL VALVES TO OPTIMIZE PRESSURE

Control valves are regulating valves. They maintain certain pressure, flow or level regardless of changes in the supply network, and therefore help reduce water losses and contribute to efficient water supply. AVK supplies a complete range of control valve solutions for water utilities. AVK control valves Series 859 are used to provide optimum pressure and flow conditions at any time.

A diaphragm control valve has a fix "mechanical circuit", this means the function is rigidly defined. The functions of the valve can be changed physically because of our patented modular pilot system, which enables easy fitting to other applications without replacing the valve. It can change working set points in real time, locally or remotely.

The valve is auto adaptive. It can react automatically to the different boundary conditions or interacting with other electronic devices in order to build a distributed intelligent system.

AVK valves are intelligent because they can take decisions independently from the SCADA. This skill is mandatory for security and reliability reasons, especially in extreme conditions as black out or a leak of communication between the devices.



A pressure sustaining control valve (PSV) automatically maintains a minimum pre-set inlet pressure by relieving excess pressure, regardless of changes in flow rate.

Accurate pilot operated control valves are used for pressure sustaining, back pressure or unloading functions in a by-pass system application.

The pressure sustaining pilot reacts to small changes in the inlet pressure, controlling the valve position. If the inlet pressure falls below the set point, the main valve closes or modulates to ensure a minimum inlet pressure. The sustaining valve holds a minimum back pressure on the inlet and normally allows flow. The relief valve normally remains closed and only opens when pressure exceeds a pre-determined set-point.

Example: The pressure is 7-8 bar, which is appropriate to supply the consumers in Area A. Therefore, a pressure reducing control valve is installed to reduce the pressure to 3 bar in Area B

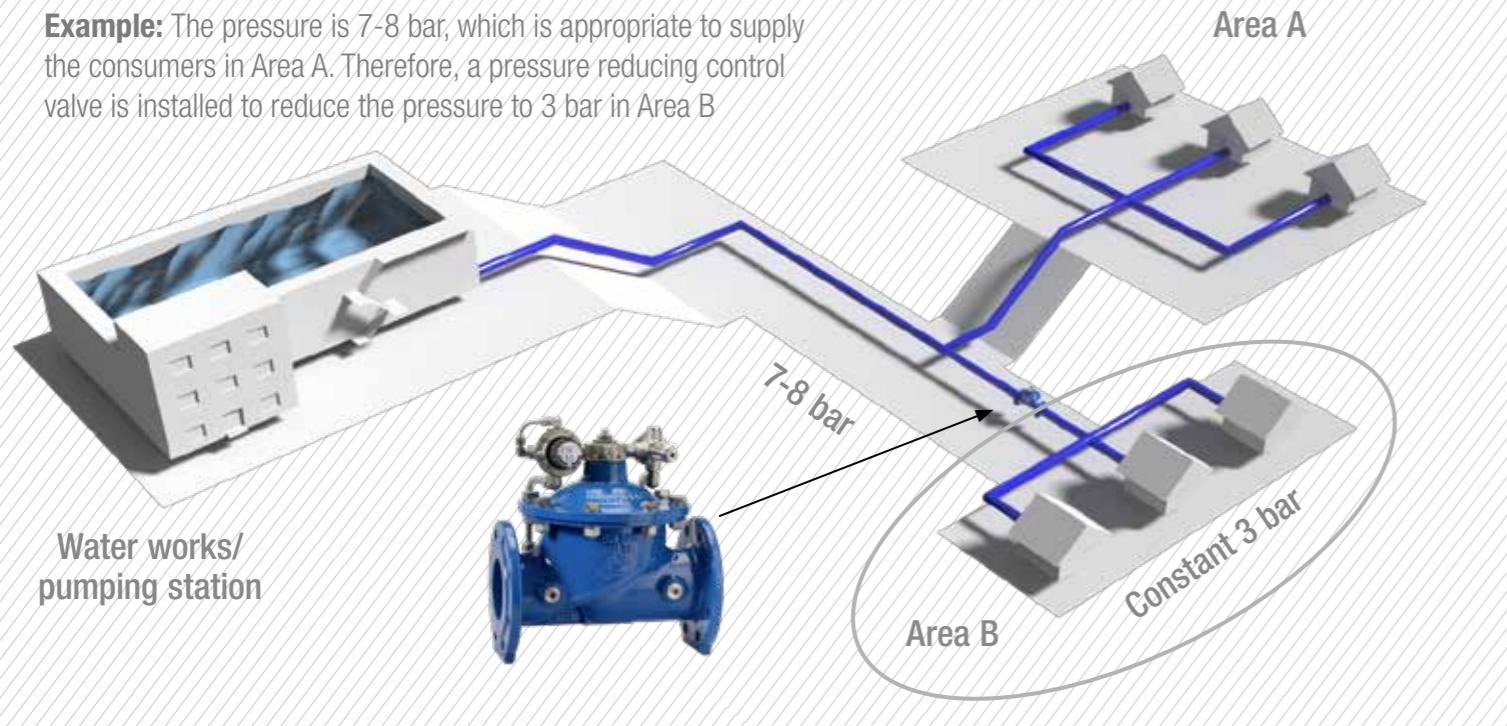

PMA before PRV's installation

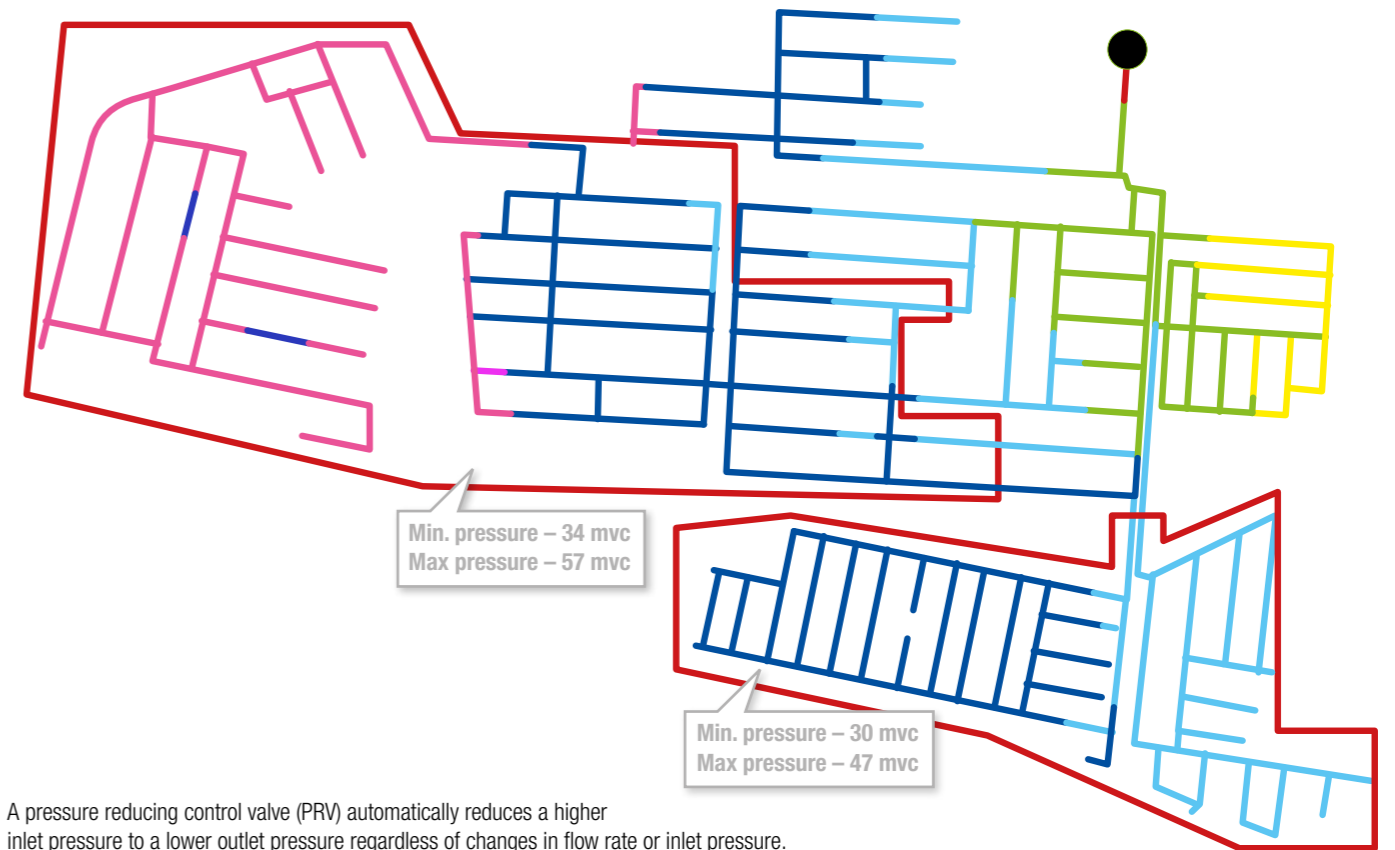

A pressure reducing control valve (PRV) automatically reduces a higher inlet pressure to a lower outlet pressure regardless of changes in flow rate or inlet pressure.

The pressure reducing pilot senses the outlet pressure through the connection on the valve outlet port. Under flowing conditions, the pressure reducing pilot reacts to small changes in the outlet pressure, controlling the valve position by modulating the pressure in the control chamber. When the outlet pressure changes according to the set-value of the pilot, the pilot modulates to ensure pressure control.

PMA after PRV's installation

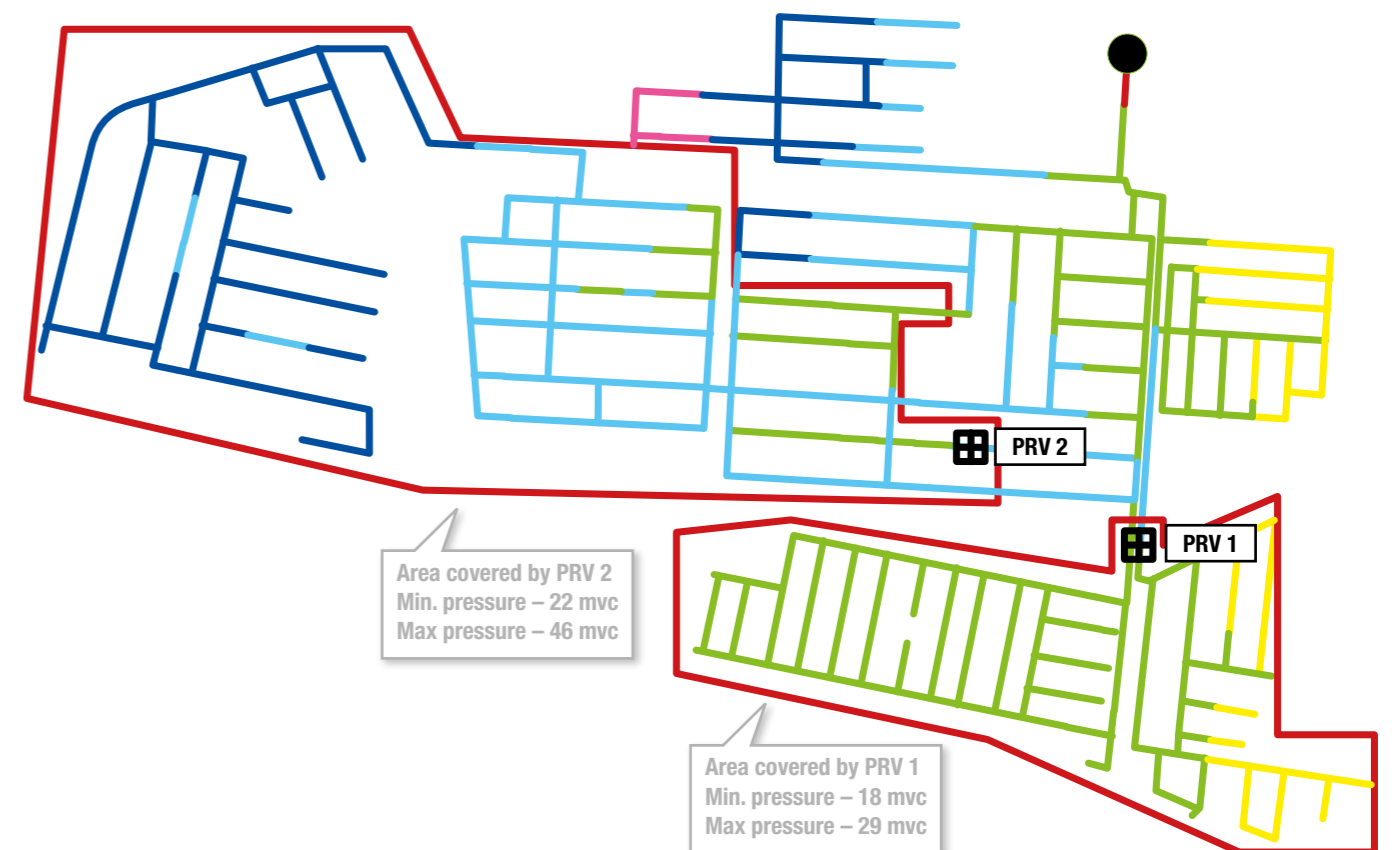

USING CONTROL VALVES TO OPTIMIZE PRESSURE

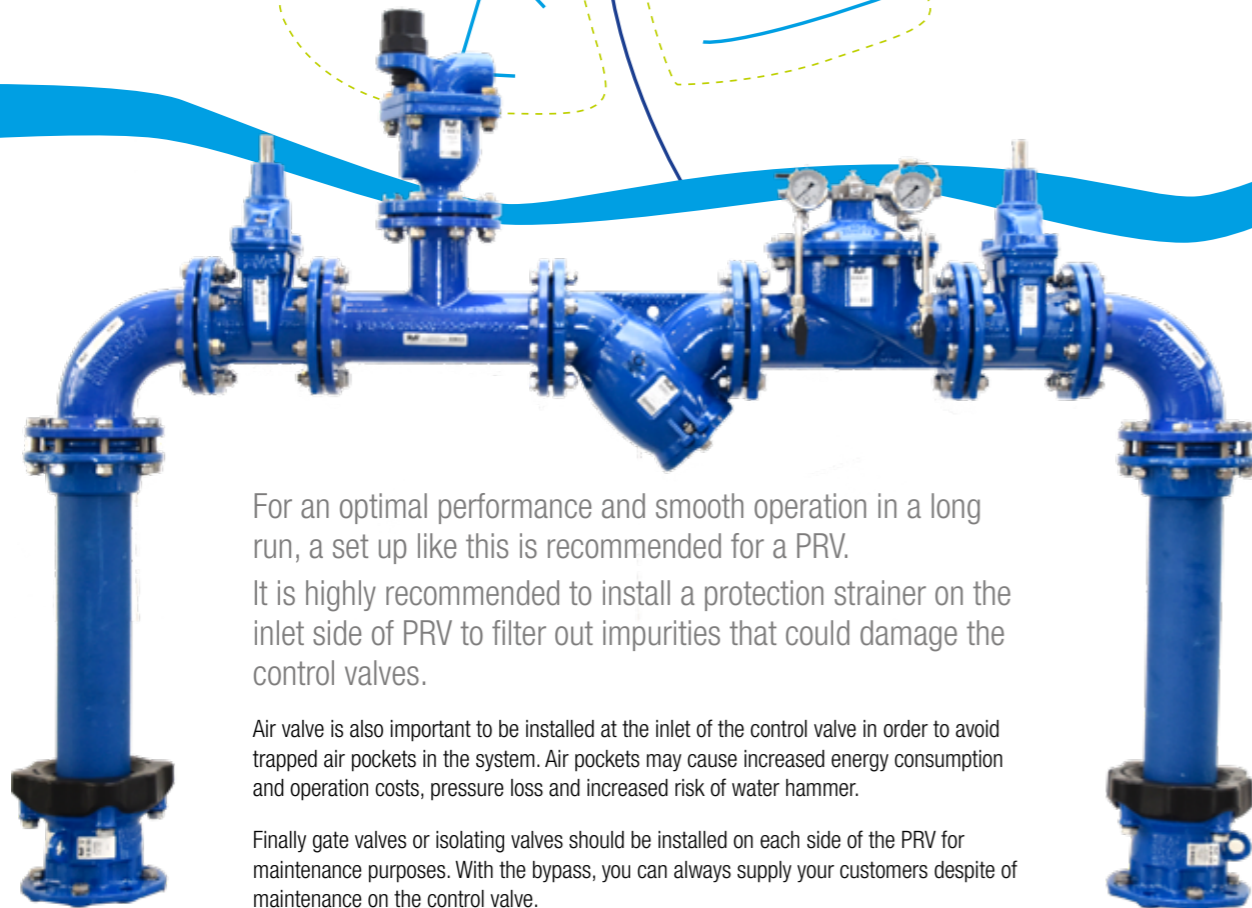
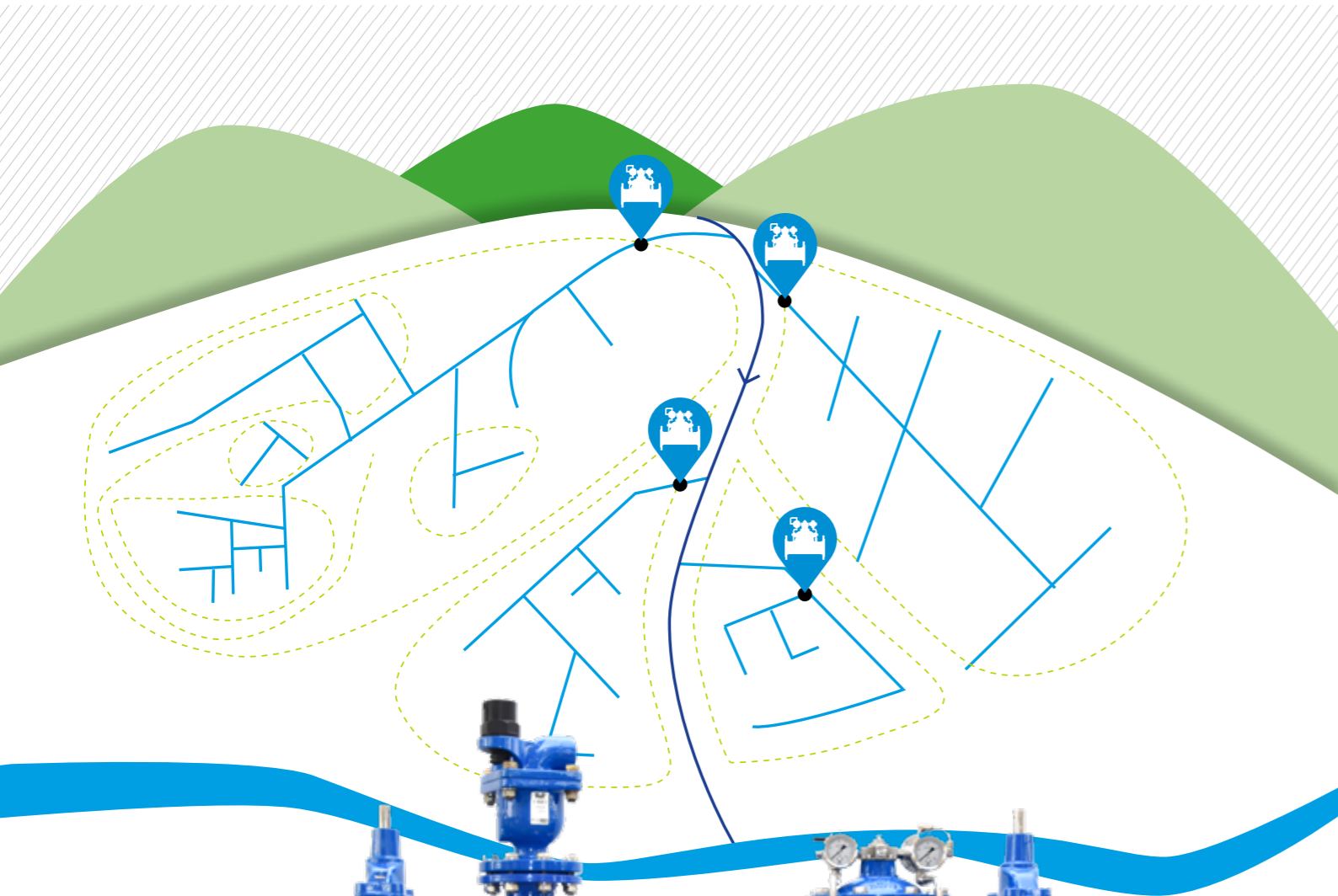

For an optimal performance and smooth operation in a long run, a set up like this is recommended for a PRV. It is highly recommended to install a protection strainer on the inlet side of PRV to filter out impurities that could damage the control valves.

Air valve is also important to be installed at the inlet of the control valve in order to avoid trapped air pockets in the system. Air pockets may cause increased energy consumption and operation costs, pressure loss and increased risk of water hammer.

Finally gate valves or isolating valves should be installed on each side of the PRV for maintenance purposes. With the bypass, you can always supply your customers despite of maintenance on the control valve.



Surge anticipation valve: Automatically protects the pipe system against pressure surges, mainly happening at pump start-up, or in the event of failure.

Description:

This model is used to control and eventually dissipate surges within a pipeline commonly caused by pump failure or system issues.

Operation:

The 2 pilots control a maximum set point and minimum set point. they are hydraulic balanced to enable the valve to slowly control any fast moving dynamic changes until they balance out and a constant pressure is reinstated to the system.

Example:

A pump fails and causes a fast rise in pressure, followed by a quick slump. the surge anticipation pilot counteract the surge and smooth the network pressure.



Constant flow valve: automatically maintains the flow demand, regardless of changes in inlet or outlet pressure.

Description:

This model automatically prevents excessive flow demand by limiting flow to a maximum rate regardless of line pressure changes.

Operation:

The rate of flow pilot senses the pressure differential across an orifice plate located downstream of main valve. When the pressure drop across the orifice plate exceeds the set point, main valves close slightly, limiting the flow. Accurate control is assured as very small changes in the differential pressure across the orifice plate occur.

Example:

A reservoir is filling too fast and the turnover of water within the reservoir is too low. A OFV is installed to limit the flow insuring the reservoirs fills at a constant rate so the storage has a chance to drop and keep the water turning over thus avoiding quality problems.

Network Pressure



Modulated / Controlled Outlet

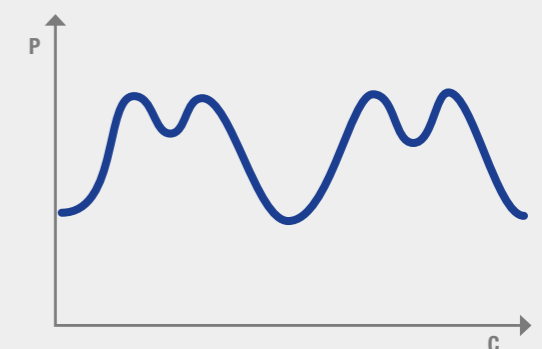

INTELLIGENT CONTROL VALVES

DEMAND DRIVEN PRESSURE MANAGEMENT

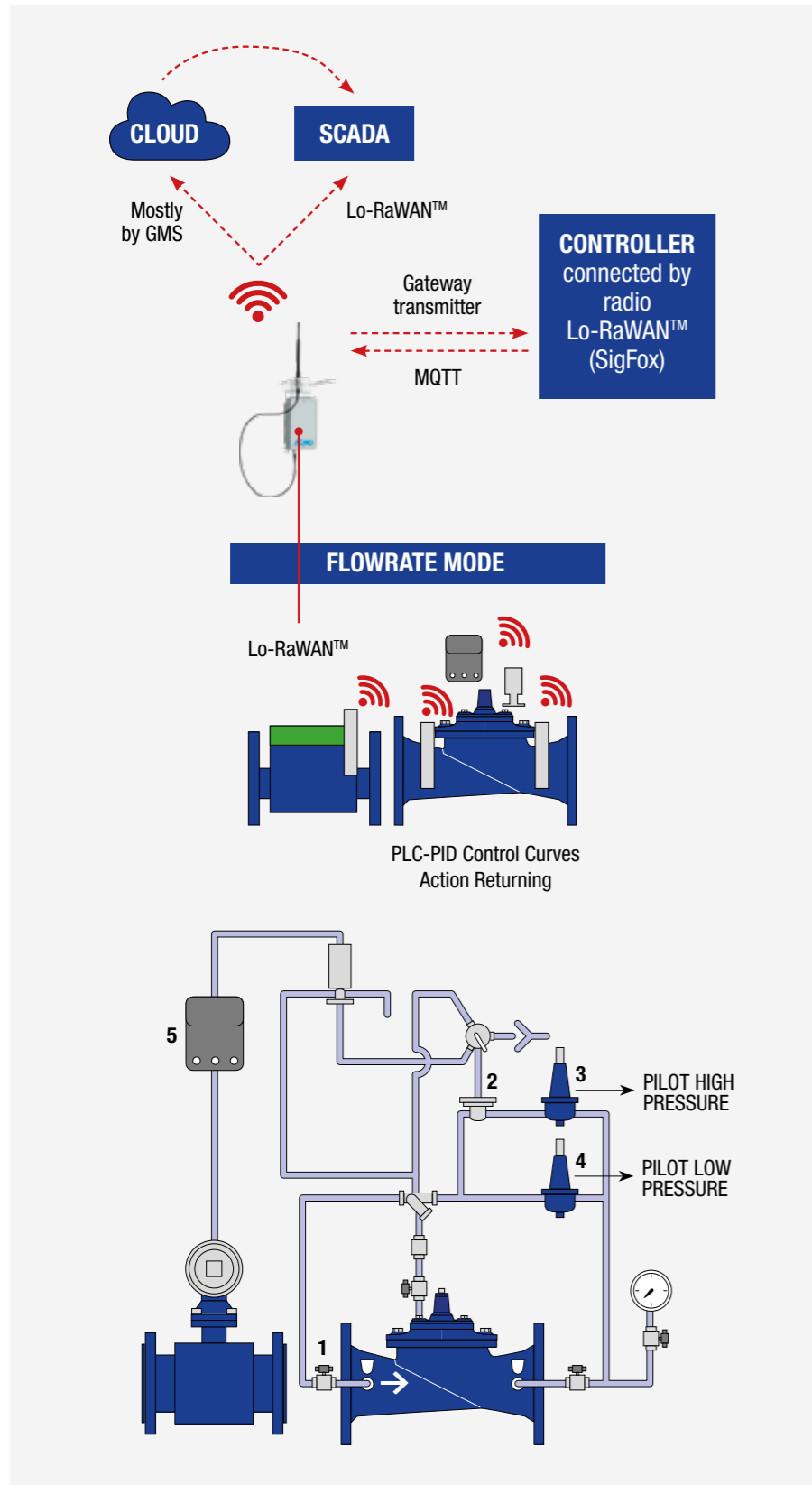

The valve is operated by two 2-way pilots 3-4 for pressure reduction with pre-set adjustable values and activated by the controller 5, acting on an auxiliary accelerator valve 2.

In low pressure conditions the 2-way valve 2 is closed while pilot 3 is working. In high pressure conditions, according to the customer's settings, solenoid switches to high pressure circuit pilot 4.

The flow in and out of the main chamber is controlled by needle valve 1 for the opening speed regulation. M117 valve can operate on time or flowrate conditions. In the second case the controller has to be connected with a flowmeter dry contact output pulse.

The time-mode pressure management solution is to adjust/regulate the PRV downstream/outlet pressure according to Night and Day time, which can be calibrated and pre-set normally with a higher daytime pressure and a lower night-time pressure. It is typically employed to reduce night time pressure and therefore force down leakage levels. With daily and weekly programming, the controller is battery operated with a standard average lifespan of 10 years if used on a daily basis.

The flowrate-mode pressure management solution is to adjust/regulate the PRV downstream/outlet pressure according to changes in demand (flowrate). It is typically employed to compensate for the effects of head loss within a distribution network or help balance pressure managed areas when there is a more than one feed or seasonal demand. Threshold flowrate can be set between "high" and "low" conditions.

In this case the controller has to be connected with a flowmeter dry contact output pulse. One key advantage is that the flowrate mode option will not compromise the water supply in the case of need for big volumes to fire fighting.

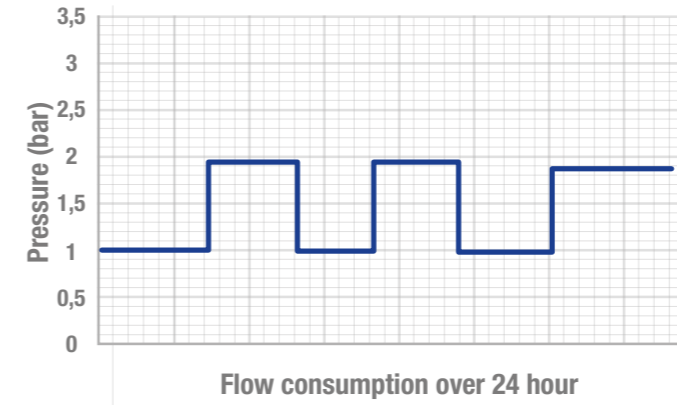

The illustration shows a two pilot operated control valve that reacts on the daily flow into the pressure zone.

The control box is constant monitoring the flow rate from the flow meter. According to the flow, the control box will keep one of the two pilot valves active in order to have the pressure adjusted to either low pressure corresponding to low flow, or higher pressure corresponding to a higher flow. E.g. at night time when water consumption is low, the pressure will be adjusted to minimum service pressure level, and during day time when the consumption is high the pressure will be increased for all consumers to have adequate water at the tap. The system is not able to react on unforeseen happenings, if i.e. an unexpected water consumption.



INTELLIGENT CONTROL VALVES ARE A VITAL TOOL FOR SMART NETWORKS!

Reducing the pressure is the only major method of reducing the overall leakage level. This graph shows the time schedule lowering the pressure at night. The yellow line is the downstream pressure. The red line is the upstream pressure and the blue line is the flow. You can see how the valve accurately controls the downstream pressure regardless of any changes in the upstream pressure.

AVK intelligent control valve has been a proven solution for reducing leakage and burst frequency, bringing optimal and cost effective pressure control to your network. How can intelligent control valves contribute to a smart network?

- Provide optimized and calm network pressures
- Offer Pressure Feedback – Alarms
- Offer Valve Position Feedback – Alarms
- Verify Zones/Pressure Management Areas (PMAs)
- React to System Failures – Isolate Bursts, Re-Zone Areas
- Reduce Leakage
- Increase/Decrease Reservoir Flows
- Remote-Control Storage Level
- Work Alongside Other Equipment – Pumps, Meters
- Prolong Asset Life – Control Maintenance Periods
- Feedback Water Temperature and Quality

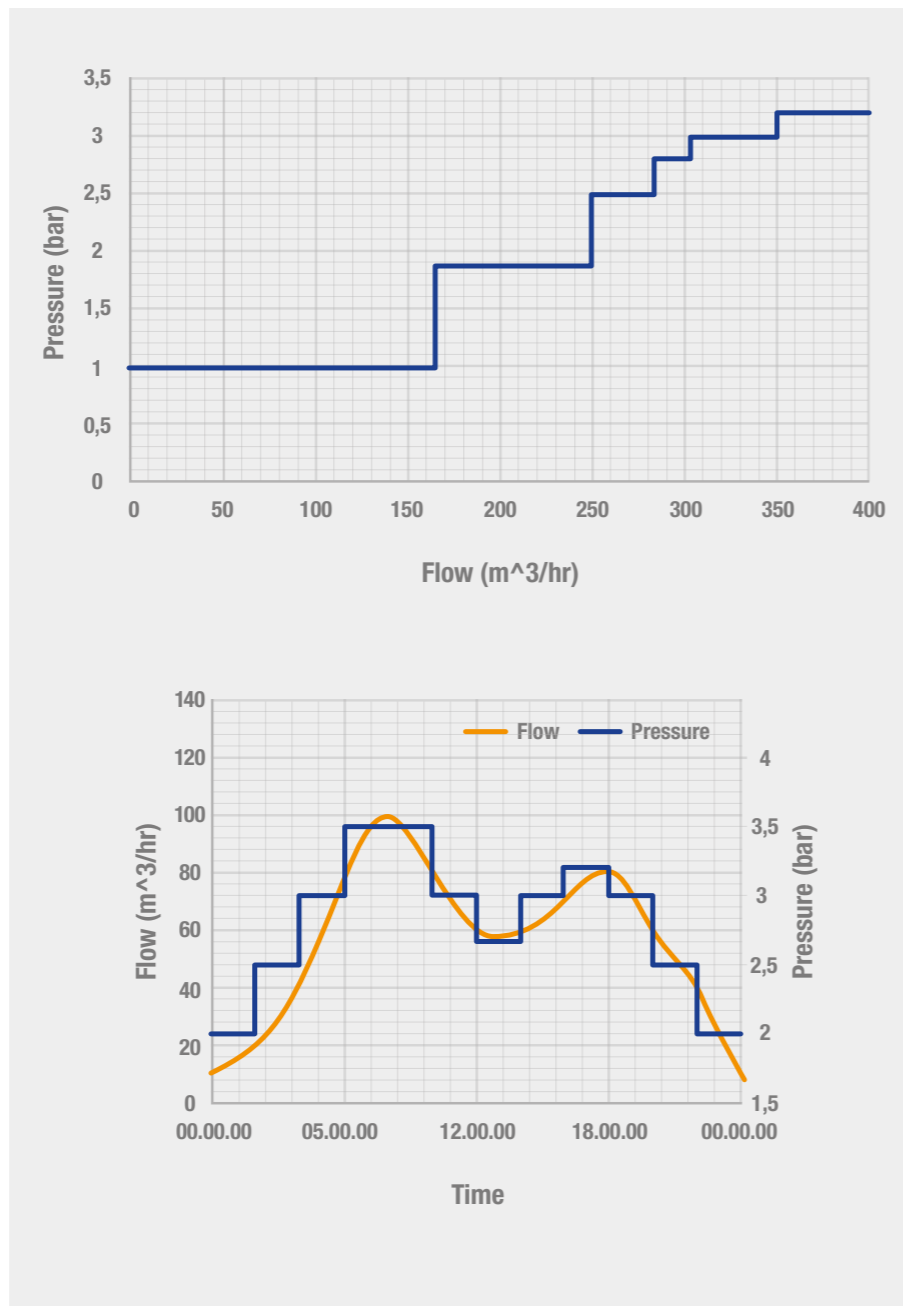

A Smart Water Network is an integrated set of products, solutions and systems that enable utilities to remotely and continuously monitor and diagnose problems, prioritize and manage maintenance issues and use data to optimize all aspects of the water distribution network. Managing distribution of water correctly can save money and ensure the overall performance of the network is improved.



The AVK control valve series 859 mounted with the ACMO PMD communication device is a local controller that can provide a wide range of control applications in a SMART pressure management system.

The features are a highly accurate control and auto-adaptive PID in order to fit the valves for a multitude of different hydraulic conditions.

The ACMO PMD is supplied with pre-configurable hydraulic control functions and data-logging features, that enable the operator to preset conditions for flow and pressure.

The unit will communicate with flow meter and adjust the pressure according to flow regardless time of the day. Should an unforeseen large volume of water been consumed leading to a higher flow, the unit will increase the pressure, in order to deliver more water and to avoid pressure fluctuation in the pressure zone. Once the flow is returning to normal condition, the system will automatically adjust to lower pressure again.

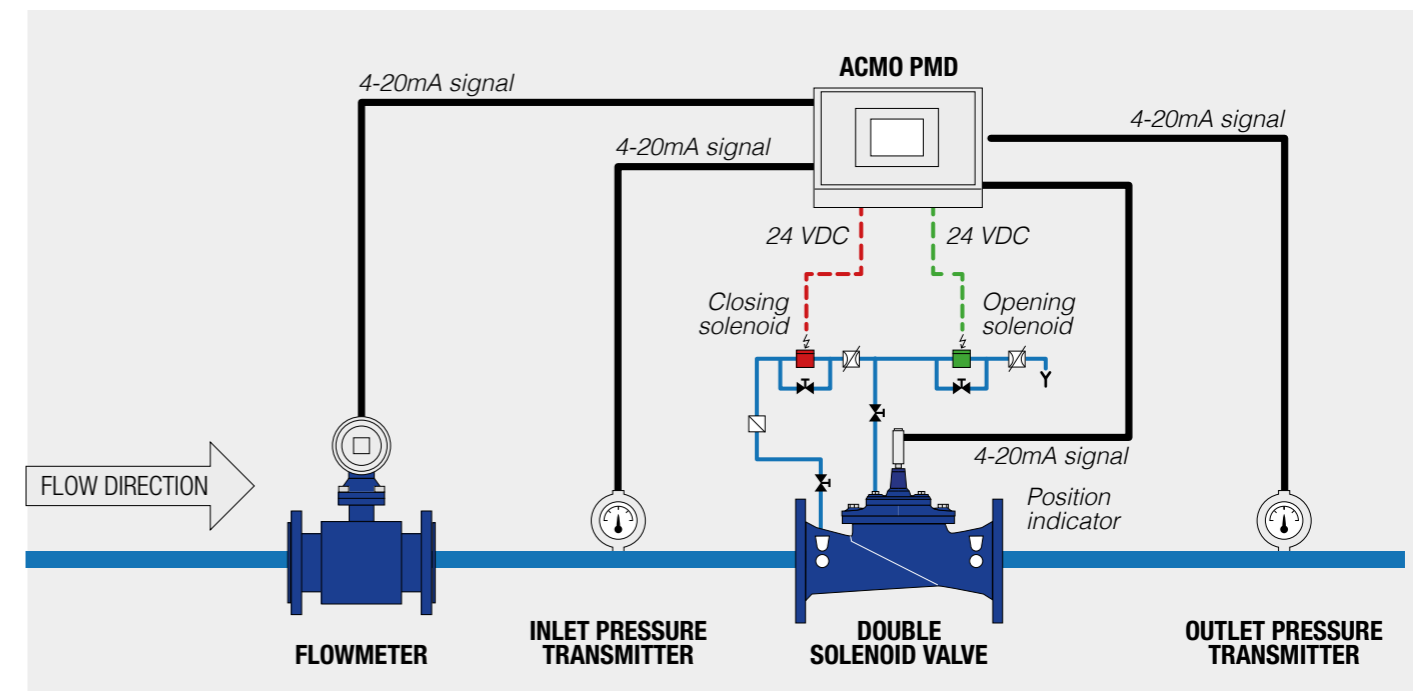

CASE STORY

DANISH WATER UTILITY CHALLENGED BY PIPE FRACTURES

AVK was approached by a water utility, Strømmen Vandværk in Randers, Denmark, which was challenged with pipe fractures due to excessive pressure in the water lines. The distribution network has a height difference of 40 meters, and the water utility placed in the high end gives a very high water pressure in the lower end of the distribution network. This results in a district within the supply area being exposed to frequent pipe fractures - the consequence of which being heavy repair costs and an increased water waste.

The water utility is already equipped with a SCADA system, but they also wanted intelligent control valves to control the pressure in defined pressure zones based on consumption and circadian rhythm. Also, it was important to the water utility to be able to close the control valves remotely via their SCADA system. With this extra feature, they will be able to close each section very easy and fast, in the case of a pipe burst. This will give the water utility control of their system - and not the other way around. A flow-meter and a control valve was installed in the inlet chamber to each one of the four pressure zones. The meter sends data to a programmable logical computer (PLC) and to the SCADA system. This way, the water utility is able to detect even small leakages and get an alarm in case the consumption rises compared to normal conditions, which indicates a leakage.



The system was activated at 15.00 hour.
Interesting to see that the upstream pressure stabilizes after the start of the control valve.

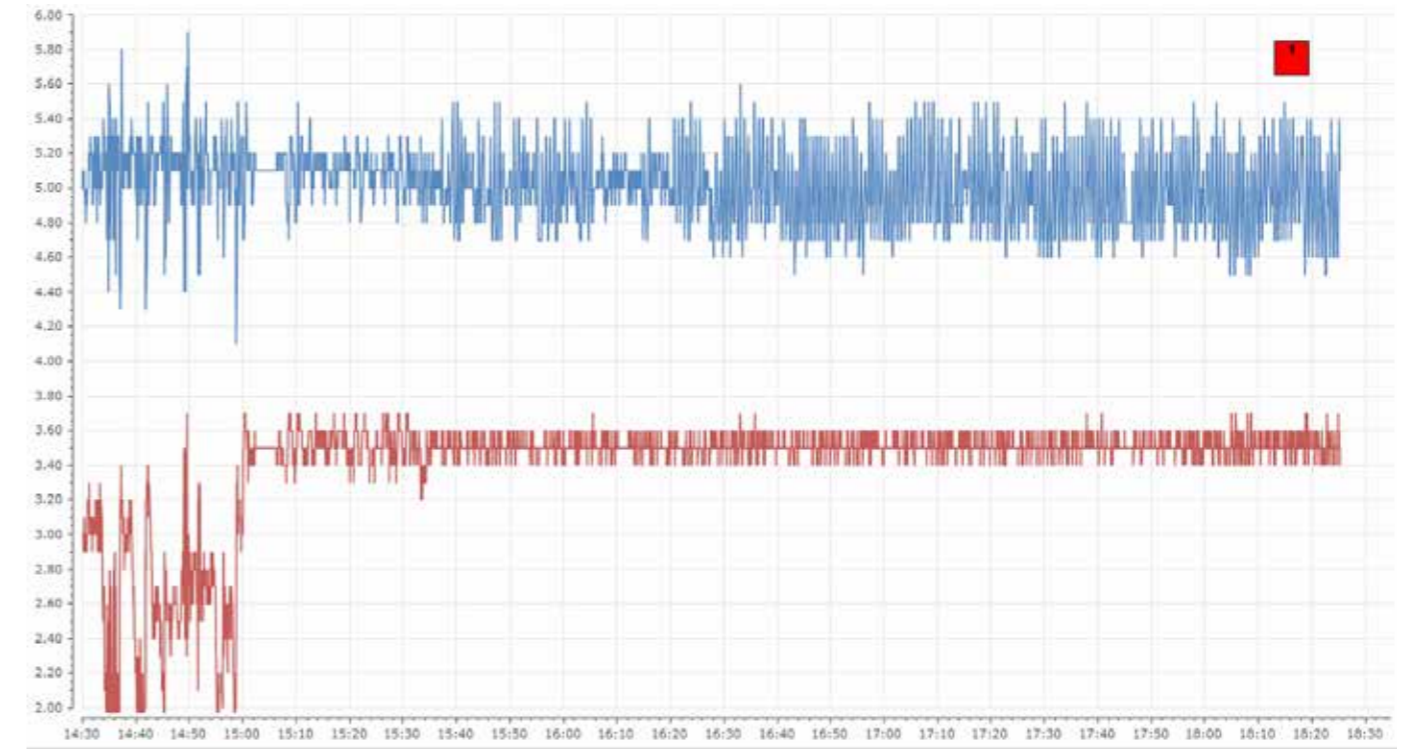

— Blue line is the pump pressure at the entrance of the pressure zone.
— Red line is the pressure in the pressure zone.

When control valves are installed with PLC control, it is possible to lower and maintain the pressure at a constant level. Additionally, it is possible to make a time schedule and lower the pressure to different set points, so the pressure during day-time would be 3 bar, and only 1.5 bar at night, when the consumption is low.

The entire supply area is divided into four pressure zones, as said, and the supply pressure in each zone based on requirements and the build-up area is set up. Next step was to test the valves installed at the borderline of the different zones, to ensure a tight shut-off of the pipes connecting the different zones before the control valves was installed. If you want to control the pressure within a zone, it is imperative that these valves are tight to prevent pressure from the neighboring zone interfering the operation. In the case of more entrances, it is important that each entrance is operated by its own control valve.

Obtaining a valuable overview

Prior to above, there was a comprehensive task of dividing the entire supply network into separate pressure zones. The network was split into four zones, each to have an inlet chamber established. The chamber have an intelligent control valve mounted alongside an ultrasonic water meter, which will then measure the volume entering the pressure zone. This is very valuable information, as the network obtains a full overview of how much water enters a specific zone held against how much is actually consumed by the network customers - all relative to the specific time of day. This way, Strømmen Vandforsyning was able to start establishing parameters for the pressure adjustments within the zone based on the collected network data. In other words, the pressure will be following the water demand, reducing the pressure when possible to the minimum service pressure promised to network customers.

This way of regulating the pressure can also be used actively for controlling pressure elsewhere in the pressure zone. There might be areas with great pressure losses when consumption is high, which can happen with old, internally overgrown pipes reducing the flow or if the piping is too narrow for

the actual water demand. By logging data on flow and pressure in this critical area, the control valve can be programmed to regulate the pressure and keep it at a constant level within the area.

Having the control valve adjusting the pressure constantly is not only saving water and energy, but is also stabilizing the overall pressure which has a direct positive impact on the pipeline system lifespan.

Communication

In the well, and alongside the control valve, a PLC (programmable logical computer) controller is mounted which communicates directly with the network's SCADA system on a regular frequency. The network manager has an app installed on his smartphone which is connected to the SCADA system via the internet. This way, he is not dependent on being situated in the network's control room to be able to monitor and control activities. Should a pipe burst be reported outside of hours, he is able to ask the control valve shut off the supply via the app, saving valuable time - and water. Data is exchanged between the valves and the SCADA system every other second, but this span might be adjusted to fit needs and future possibilities.

Supplying power

Both the controller and the valve need power to be able to work, and supplying this caused a bit of trouble for the project. Should the network be connected to a lamppost or traffic lights? How about a back-up battery supported by a water turbine to keep it charged? Or, would an entire power supply be necessary? Many scenarios and considerations later, the decisions was made to play it safe, and to have an own power supply established from the public network. When the system has been up and running for some time, it will be possible to analyze data from power use and to evaluate other sources such as solar cells, water turbines etc.

CASE STORY

AVK WIN AN IMPRESSIVE ORDER BASED ON A PRODUCT AND SOLUTION PACKAGE



Case Location: Tbilisi, Georgia – Georgia Water and Power (GWP)

- Planned installation of more than 500 PRVs series 859, DN50-300 PN16 to reduce water loss
- Expected reduction of pumped water is 58,000,000 m³/year
- The saving alone on producing this amount of water is nearly 6.4 million USD per year

After installation 235 PRVs, the savings are:

- GWP saved 28million cubic meters of water per year
- Consumption of electricity for water treatment and distribution is reduced by 8-10%

AVK UK and AVK International are currently working together with Georgia Water and Power for the supply of over 350 Series 859 control valves. The valves are to be installed as part of a leakage reduction initiative in Tbilisi, Georgia's capital city.

AVK were awarded the contract for the supply of the control valves despite serious competition from cheaper competitors, but GWP were very clear their requirements were for high quality valves with excellent support and therefore acknowledged the benefits of using AVK and their Series 859 valves.

Following the initial technical discussions and benefits of S859 over other control valves in Tbilisi, AVK were also able to provide GWP with further technical assurances using their test facility at Bryan Donkin Valves in Staveley (where the valves are manufactured), to ensure the customer was fully satisfied with the specifications and operational performance. Various trials were performed and videos and data logging results were provided to GWP to confirm that they had selected a superior product and could be confident of complete technical support.

David Hurley - AVK UK Technical Sales Manager for Series 859 and Elmira Haansbaek - AVKI Regional Sales Manager for Georgia; have been working closely with GWP in Tbilisi assisting with ensuring correct valve specification is supplied, and ensuring the high level of support you would expect from AVK.

During April 2016 David and Elmira visited several PRV installations and gave comprehensive training to local technicians. During this time the technical team from GWP were shown how to commission and maintain the valves as well as in-depth troubleshooting methods. Data was also taken during the visit to prove the valves were performing to the accuracy required.

With the supply and installation initiative still on-going, AVK and GWP are already looking into the next step for the pressure control programme. Methods of data collection and advanced pressure control have already been discussed and due to be implemented later on in the year.



AVK Group
www.avkvalves.com
Copyright AVK Group A/S 2018

Expect... **AVR**